

1

1 NOV 24 1947

CLASSIFICATION CANCELLED

McDonnell P-85 1/2

RESTRICTED

RM No. L7J16

Copy No. 1

CLASSIFICATION CANCELLED

PERMANENT FILE COPY

Authority *J.W. Cowley 12/14/53*  
Aeron. Research  
NACA

**NACA**

by *OCS*  
*Status: Inactive*  
NACA change # 2166

# RESEARCH MEMORANDUM

for the

Air Materiel Command, Army Air Forces

STABILITY AND CONTROL CHARACTERISTICS OF A  $\frac{1}{10}$ -SCALE

MODEL OF THE MCDONNELL XP-85 AIRPLANE WHILE

ATTACHED TO THE TRAPEZE

By

Joseph L. Johnson

Langley Memorial Aeronautical Laboratory  
Langley Field, Va.

CLASSIFICATION CANCELLED

CLASSIFIED DOCUMENT

This document contains classified information affecting the National Defense of the United States within the meaning of the Espionage Act, USC 50:31 and 32. Its transmission or the revelation of its contents in any manner to an unauthorized person is prohibited by law. Information so classified may be imparted only to persons in the military and naval services of the United States, appropriate civilian officers and employees of the Federal Government who have a legitimate interest therein, and to United States citizens of known loyalty and discretion who of necessity must be informed thereof.

CONTAINS PROPRIETARY INFORMATION

**NATIONAL ADVISORY COMMITTEE FOR AERONAUTICS**

WASHINGTON

FILE COPY

To be returned to the files of the National Advisory Committee for Aeronautics Washington, D. C.

NOV 17 1947

CLASSIFICATION CANCELLED

RESTRICTED

10



## NATIONAL ADVISORY COMMITTEE FOR AERONAUTICS

## RESEARCH MEMORANDUM

for the

Air Materiel Command, Army Air Forces

STABILITY AND CONTROL CHARACTERISTICS OF A  $\frac{1}{10}$ -SCALE

MODEL OF THE MCDONNELL XP-85 AIRPLANE WHILE

ATTACHED TO THE TRAPEZE

By Joseph L. Johnson

## SUMMARY

At the request of the Air Materiel Command, Army Air Forces, an investigation of the low-speed, power-off, stability and control characteristics of the McDonnell XP-85 airplane has been conducted in the Langley free-flight tunnel. The results of the portion of the investigation consisting of tests of a  $\frac{1}{10}$ -scale model to study the stability of the XP-85 when attached to the trapeze and during retraction into the B-36 bomb bay are presented herein.

In the power-off condition the stability was satisfactory with all oscillations well damped and the nose-restraining collar could be placed in position without difficulty. In a simulated power-on condition the model had a constant-amplitude rolling and sidewise motion and when the collar was lowered, a violent motion resulted if the collar struck the model but failed to hold it in the proper manner. Folding of the wings and retraction into the bomb bay offered no problem once the airplane was properly held by the collar. It is recommended that the power be cut immediately after hooking on and that a restricting mechanism be incorporated in the center of the trapeze to eliminate the sidewise motion. It also appears desirable to have the retracting procedure controlled by the XP-85 pilot or an observer in the mother ship to insure that the parasite is in proper position after hooking up before bringing the collar down.

## INTRODUCTION

An investigation of the low-speed, power-off, stability and control characteristics of the McDonnell XP-85 airplane has been conducted in the Langley free-flight tunnel at the request of the Air Materiel Command, Army Air Forces. The first portion of the investigation consisting of



preliminary force and flight tests of a  $\frac{1}{5}$ -scale model was reported in reference 1. The second portion of the investigation was made using a  $\frac{1}{10}$ -scale model to determine the stability characteristics of the XP-85 when attached to the trapeze for retraction into the B-36 bomb bay. The results of tests on the  $\frac{1}{10}$ -scale model along with force-test data from reference 1 are presented herein. The first portion of the investigation was made using the larger model because it would provide more reliable aerodynamic data and would make the flight-testing easier. The smaller model was used for the second portion because it permitted the representation of the proper scaled-down weights and moments of inertia not possible with the larger model for use in this tunnel.

The XP-85 is a jet-propelled, parasite fighter designed to be carried in the forward bomb bay of the B-36 airplane. In the combat area when the need for fighter escort arises, the XP-85 is lowered from the B-36 on a trapeze arrangement and released. When further fighter protection is not required, the XP-85 returns to the mother ship and is secured to the trapeze. The wings are then folded upward and the XP-85 is drawn up into the bomb bay.

The present investigation included tests to determine the stability of the model when attached to the trapeze and during retraction into the bomb bay of the B-36. All tests were made with stall-control vanes installed. The actual hook-on of the flying model to the trapeze was not investigated because the high wing loading and low maximum lift coefficient of this  $\frac{1}{10}$ -scale model made flight tests impossible with the existing equipment. For the same reason, stability in free flight could not be investigated for the model at the correct scaled-down values of weight and moments of inertia.

#### SYMBOLS

S	wing area, square feet
$\bar{c}$	mean aerodynamic chord, feet
b	wing span, feet
q	dynamic pressure, pounds per square foot
$\rho$	air density, slugs per cubic foot
m	mass density, slugs per cubic foot
$\mu$	relative density factor ( $m/\rho S b$ )
$\alpha$	angle of attack of fuselage center line, degrees



$\beta$	angle of sideslip, degrees
$\psi$	angle of yaw, degrees
$C_L$	lift coefficient (Lift/ $qs$ )
$C_D$	drag coefficient (Drag/ $qs$ )
$C_m$	pitching-moment coefficient (Pitching moment/ $qs\bar{c}$ )
$C_n$	yawing-moment coefficient (Yawing moment/ $qSb$ )
$C_l$	rolling-moment coefficient (Rolling moment/ $qSb$ )
$C_Y$	lateral-force coefficient (Lateral force/ $qs$ )
$i_t$	tail incidence, degrees
$\delta_e$	elevator deflection, degrees
$\delta_a$	aileron deflection, degrees
$C_{Y\beta}$	rate of change of lateral-force coefficient with angle of sideslip, per degree ( $\partial C_Y / \partial \beta$ )
$C_{n\beta}$	rate of change of yawing-moment coefficient with angle of sideslip, per degree ( $\partial C_n / \partial \beta$ )
$C_{l\beta}$	rate of change of rolling-moment coefficient with angle of sideslip, per degree ( $\partial C_l / \partial \beta$ )
$\gamma$	tunnel angle (negative in gliding flight)

## Subscripts:

U	upper
L	lower
t	tail

## APPARATUS

The investigation was made in the Langley free-flight tunnel which is designed to test free-flying dynamic models. A complete description of the tunnel and its operation is given in reference 2. The force tests to determine the aerodynamic characteristics of the model were made on



the free-flight tunnel six-component balance which is described in reference 3. The balance rotates with the model in yaw so that all forces and moments are measured with respect to the stability axes. (See fig. 1.) The tests to determine the behavior of the model upon hooking up and during retraction were made using a  $\frac{1}{10}$ -scale model of the forward portion of the bomb bay of the B-36 bomber which was mounted on the ceiling of the Langley free-flight tunnel (fig. 2). A trapeze arrangement furnished by McDonnell Aircraft Corporation was attached to the bomb bay and used as a support for the model. The nose-restraining collar attachment shown in figure 2 was lowered to clamp the model in position for retraction into the bomb bay.

### Model

The  $\frac{1}{10}$ -scale model used in the investigation was constructed at the Langley Laboratory. A three-view drawing of the model is presented in figure 3 and photographs of the model are shown as figures 4 and 5. Table I gives the dimensional and mass characteristics of the full-scale airplane and scaled-up dimensional and mass characteristics of the model. As may be seen from table I, the model had approximately correct scaled-down values of mass and moments of inertia. The wing of the model was constructed in two panels with each panel pivoted at the fuselage-wing juncture. The distance from the leading edge of the root chord to the nose for the  $\frac{1}{10}$ -scale model was 1.78 feet full-scale, whereas this distance for the model of reference 1 was 2.19 feet full-scale. The folding of the panels from the normal flight position to a vertical position was accomplished in about 10 seconds by means of a linkage system and a small, constant speed, geared-down motor. Since a small portion of the linkage extended out of the wing and disturbed the flow at the wing-fuselage juncture, it was necessary to fair this protuberance with thin sheet rubber.

The wing had a modified Rhode St. Genese 35 airfoil section. The substitution of this section for that specified for the full-scale design (NACA 65-010) was in accordance with the free-flight-tunnel practice of using airfoil sections that obtain maximum lift coefficients in the low-scale tests more nearly equal to those of the full-scale designs. The trailing edge of the wing was reflexed  $10^\circ$  to trim out the pitching moment of the airfoil due to the high camber, and the wing incidence was set at  $0^\circ$  with  $5^\circ$  washout at the tips. All tests were made with the five-unit tail arrangement and with stall-control vanes added to the model wing at half semispan and parallel to the plane of symmetry.



## TESTS

Force tests.- Force tests were made to determine the static stability characteristics of the model. All force tests were run at a dynamic pressure of 3.0 pounds per square foot, which corresponds to an airspeed of 34 miles per hour at standard sea-level conditions and to a test Reynolds number of 164,000 based on the mean aerodynamic chord of 0.516 foot. All forces and moments for the free-flight-tunnel model are referred to the stability axis originating at the center-of-gravity position of 26.7 percent of the mean aerodynamic chord and 5.3 percent mean aerodynamic chord above the thrust line.

Hook-on and retraction tests.- Tests were made to study the stability problems associated with hook-on to the trapeze, folding of the wings, and retraction into the bomb bay. The power-on condition was simulated in the Langley free-flight tunnel by setting the tunnel angle to the glide-path angle of the model ( $-12^\circ$ ) so that the model was nearly air-borne at the fairly high lift coefficient ( $C_L = 0.6$ ). The effect of cutting power was simulated by reducing the tunnel angle to  $0^\circ$ . These tests were made at a center-of-gravity position of 26.7 percent mean aerodynamic chord and 5.3 percent mean aerodynamic chord above the thrust line and at a dynamic pressure of 6.8 pounds per square foot which corresponds to an airspeed of 50 miles per hour at standard sea-level conditions.

## RESULTS AND DISCUSSION

Force tests.- The results of force tests made to determine the longitudinal stability characteristics of the  $\frac{1}{10}$ -scale free-flight-tunnel model and comparable data for the  $\frac{1}{5}$ -scale model of reference 1 are presented in figure 6. The pitching-moment curve indicates that the  $\frac{1}{10}$ -scale model was stable up to a lift coefficient of 0.65 at which point the curve breaks and becomes unstable up to the stall. This break in the pitching-moment curve did not appear in the  $\frac{1}{5}$ -scale-model tests with the same configuration and was probably caused by the very low scale of the tests and by the large fairing required at the wing-fuselage juncture. The lower scale and the fairing probably also caused the lower maximum lift coefficient for the  $\frac{1}{10}$ -scale model as compared to the  $\frac{1}{5}$ -scale model. The static margin ( $-dC_m/dC_L$ ) was about 0.08 greater for the  $\frac{1}{10}$ -scale model than for the  $\frac{1}{5}$ -scale model of reference 1. This may be partly accounted for by the different wing locations of the two models.



Presented in figure 7 are the results of force tests made to determine the lateral-stability parameters  $C_{Y\beta}$ ,  $C_{n\beta}$ , and  $C_{l\beta}$ . The data show the lateral-force parameter  $C_{Y\beta}$  was about 30 percent greater than that of the  $\frac{1}{5}$ -scale model. The directional-stability parameter  $C_{n\beta}$  was satisfactory over the entire lift range and was somewhat greater than that indicated for the  $\frac{1}{5}$ -scale model. This is partly due to the difference in tail lengths of the two models and to the greater  $C_{Y\beta}$  of the  $\frac{1}{5}$ -scale model. The effective dihedral parameter  $C_{l\beta}$  was about zero or slightly positive at medium and high lift coefficients. At a lift coefficient of about 0.3 the effective dihedral was more positive than that of the  $\frac{1}{5}$ -scale model and below  $C_L = 0.3$  the effective dihedral was more negative.

Hook-on and retraction tests.- In the power-on condition the model when attached to the trapeze had a constant amplitude rolling and sidewise motion as shown in figure 8. (See frames 0 to 81.) The model moved from side to side on the trapeze and the magnitude of the motion was limited only by the width of the trapeze. Efforts to control the motion with coordinated aileron and rudder control proved to be unsuccessful because it was very difficult to apply the controls at the proper time and at times control deflections appeared to reinforce the motion. Also, the rudder introduced a yawing motion that sometimes aggravated the condition by increasing the rolling motion. Ailerons alone therefore provided the most satisfactory means of controlling the motions although it was impossible to keep the model completely steady. With the sidewise movement of the model on the trapeze limited to about an inch, the model was much steadier and it therefore appears desirable that some restricting mechanism be incorporated in the trapeze to insure that the airplane be held securely in the center of the trapeze to eliminate the sidewise motion after hooking on.

The violent motion that ensued when the collar was brought down with the model in the power-on condition described above is shown in figure 8, frames 92 to 230. In this series of pictures the collar was brought down but missed the nose. The model was struck, however, and the disturbance thus imparted to the model resulted in yawing and rolling motions of about  $90^\circ$  in addition to the sidewise movement on the trapeze. It is easily seen that such behavior of the full-scale airplane might be highly disastrous for both the parasite and mother airplanes.

The effect of cutting power is shown in figure 9. The figure shows that, as the tunnel angle was reduced, the oscillation became smaller until at  $0^\circ$  tunnel angle the model was very steady (frames 0 to 426). As the tunnel angle was reduced, there was a change in angle of attack of the model from a high positive angle to a small negative angle and an accompanying change in the center-of-gravity location relative to the hook-on



point. The difference in the stability with power on and power off was probably associated with the change in the model angle of attack. With the model in the power-off attitude, no difficulty was encountered in applying the nose clamp to the model and the model was very stable with all oscillations well damped. (See fig. 10.) From the results of these tests it seems advisable to have the retracting procedure controlled by the XP-85 pilot or at least by an observer in the mother ship to insure that the parasite is in the proper position after hooking up before bringing the collar down.

The folding of the wings and retraction into the bomb bay is shown in figure 10. From this figure it is seen that the operation offers no particular problem and the model remained perfectly stable throughout the whole procedure.

### CONCLUSIONS

The following conclusions were drawn from the results of a free-flight-tunnel investigation of the stability of a properly ballasted  $\frac{1}{10}$ -scale model of the McDonnell XP-85 airplane when attached to the trapeze and during retraction into the bomb bay of the mother airplane:

1. In a simulated power-on condition the model had a constant-amplitude rolling and sidewise motion on the trapeze that was limited in magnitude only by the width of the trapeze. Lowering the collar with the model in the power-on condition resulted in a violent motion if the collar struck the model but failed to hold it in the proper manner.
2. In the power-off condition, the model had satisfactory stability with all oscillations well damped, and the collar was placed in position without difficulty.
3. Folding of the wings and retraction into the bomb bay offered no particular problem once the model was properly held by the collar.

### RECOMMENDATIONS

The following recommendations for improving the stability of the airplane while on the trapeze are made on the basis of the free-flight-tunnel tests:

1. Incorporate a restricting mechanism on the trapeze to eliminate the sidewise motion.



2. Cut power immediately after hooking on to the trapeze.
3. The retracting procedure should be controlled by the pilot of the XP-85 or an observer in the mother airplane to insure that the airplane is held securely in the center of the trapeze before the collar is lowered.

Langley Memorial Aeronautical Laboratory  
National Advisory Committee for Aeronautics  
Langley Field, Va.

*Joseph L. Johnson*  
Joseph L. Johnson  
Aeronautical Engineer

Approved: *Thomas A. Harris*

Thomas A. Harris  
Chief of Stability Research Division

RCM

#### REFERENCES

1. Paulson, John W., and Johnson, Joseph L.: Preliminary Evaluation of the Low-Speed Stability and Control Characteristics of the McDonnell XP-85 Airplane from Tests of an Unballasted  $\frac{1}{5}$ -Scale Model in the Langley Free-Flight Tunnel. NACA RM No. L7C27, Army Air Forces, 1947.
2. Shortal, Joseph A., and Osterhout, Clayton J.: Preliminary Stability and Control Tests in the NACA Free-Flight Wind Tunnel and Correlation with Full-Scale Flight Tests. NACA TN No. 810, 1941.
3. Shortal, Joseph A., and Draper, John W.: Free-Flight-Tunnel Investigation of the Effect of the Fuselage Length and the Aspect Ratio and Size of the Vertical Tail on Lateral Stability and Control. NACA ARR No. 3D17, 1943.



TABLE I

DIMENSIONAL AND MASS CHARACTERISTICS OF THE MCDONNELL XP-85  
AND SCALED-UP CHARACTERISTICS OF  $\frac{1}{10}$ -SCALE MODEL TESTED IN  
LANGLEY FREE-FLIGHT TUNNEL

	<u>Scaled-up</u>	<u>Full-scale</u>
Weight, lb . . . . .	4777	4777
Relative density factor $\mu$ , m/ $\rho S b$ . . . . .	29.8	29.8
Wing:		
Area, sq ft . . . . .	100	100
Span, ft . . . . .	21	21
Aspect ratio . . . . .	4.4	4.4
Sweepback, c/4, deg . . . . .	34	34
Incidence, deg . . . . .	0	1
Dihedral, deg . . . . .	-4	-4
Taper ratio . . . . .	0.33	0.33
Washout, deg . . . . .	5	5
Mean aerodynamic chord, ft . . . . .	5.16	5.16
Location of M.A.C. behind leading- edge root chord, ft . . . . .	3.45	3.45
Root chord, ft . . . . .	7.15	7.15
Tip chord, ft . . . . .	2.38	2.38
Distance from nose to leading-edge root chord, ft . . . . .	1.78	1.78
Wing loading, W/S, lb/sq ft . . . . .	47.77	47.77
Aileron:		
Area, percent wing area (one) . . . . .	3	3
Span, percent wing span (one) . . . . .	20	20
Hinge location, percent chord . . . . .	80	80
Nose flap:		
Area, percent wing area (one) . . . . .	2.1	2.1
Span, percent wing span (one) . . . . .	19.1	19.1
Chord, percent wing chord . . . . .	15	15



TABLE I - Concluded

## DIMENSIONAL AND MASS CHARACTERISTICS OF THE MCDONNELL XP-85 - Concluded

	<u>Scaled-up</u>	<u>Full-scale</u>
Tail:		
Vertical fin of upper vee, true area, sq ft . . . . .	8.32	8.32
Upper vee only (true), sq ft . . . . .	20.40	20.40
Horizontal projection, sq ft . . . . .	14.40	14.40
Lower vee (true), sq ft . . . . .	11.67	11.67
Horizontal projection, sq ft . . . . .	8.22	8.22
Design vertical fin, sq ft . . . . .	7.15	7.15
Center-of-gravity location,		
percent M.A.C. . . . .	26.7	26.7
Distance above thrust line, in. . . . .		
Percent M.A.C. . . . .	3.37	3.1
	0.065	0.05
Tail length (distance from L.E. root chord wing to c/4 root chord tail):		
Upper tails, ft . . . . .	9.53	9.53
Lower tails, ft . . . . .	10.30	10.30
Moments of inertia:		
$I_X$ , slug-ft <sup>2</sup> . . . . .	825	925
$I_Z$ , slug-ft <sup>2</sup> . . . . .	1814	1736
$I_Y$ , slug-ft <sup>2</sup> . . . . .	1685	1485
Radius of gyration to wing span:		
$k_X/b$ . . . . .	0.113	0.119
$k_Z/b$ . . . . .	0.166	0.163
$k_Y/b$ . . . . .	0.160	0.150



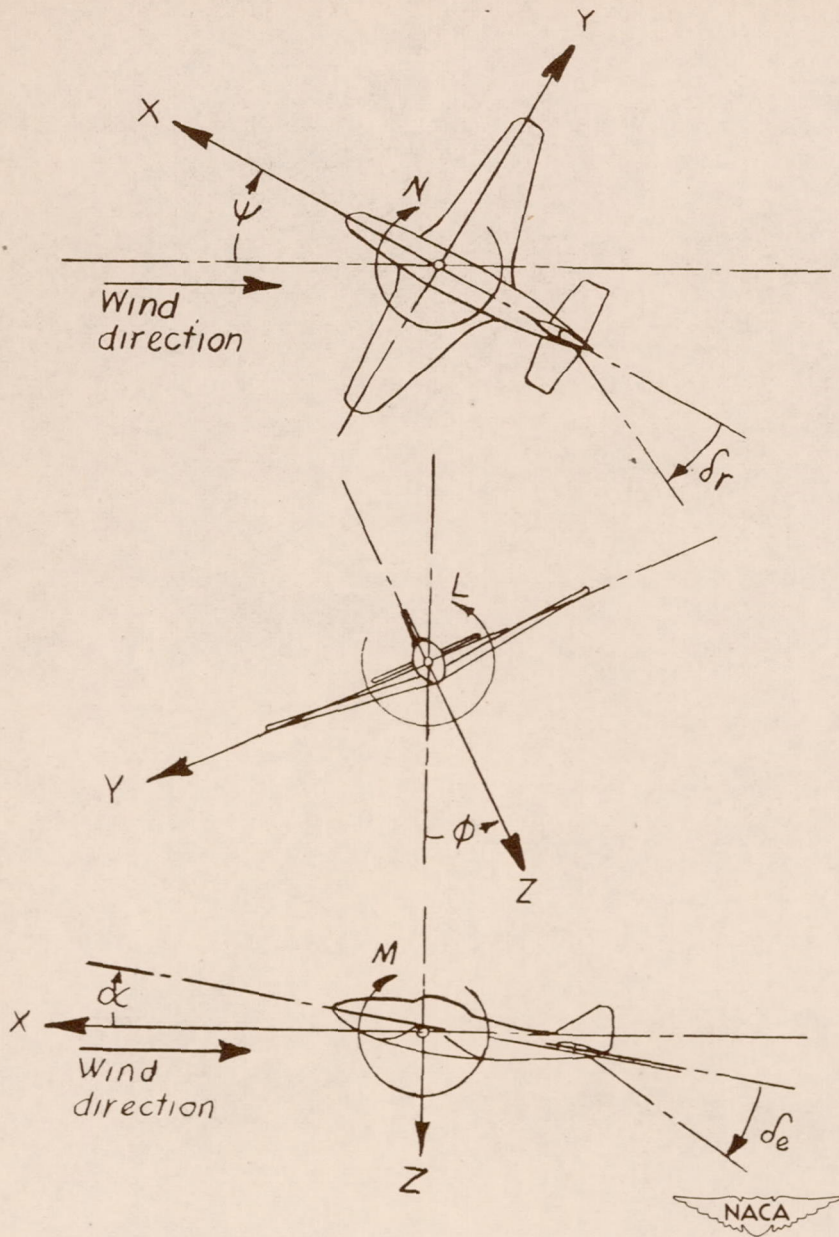

Figure 1. - The stability system of axes. Arrows indicate positive directions of moments, forces, and control-surface deflections. This system of axes is defined as an orthogonal system having their origin at the center of gravity and in which the Z-axis is in the plane of symmetry and perpendicular to the relative wind, the X-axis is in the plane of symmetry and perpendicular to the Z-axis, and the Y-axis is perpendicular to the plane of symmetry.



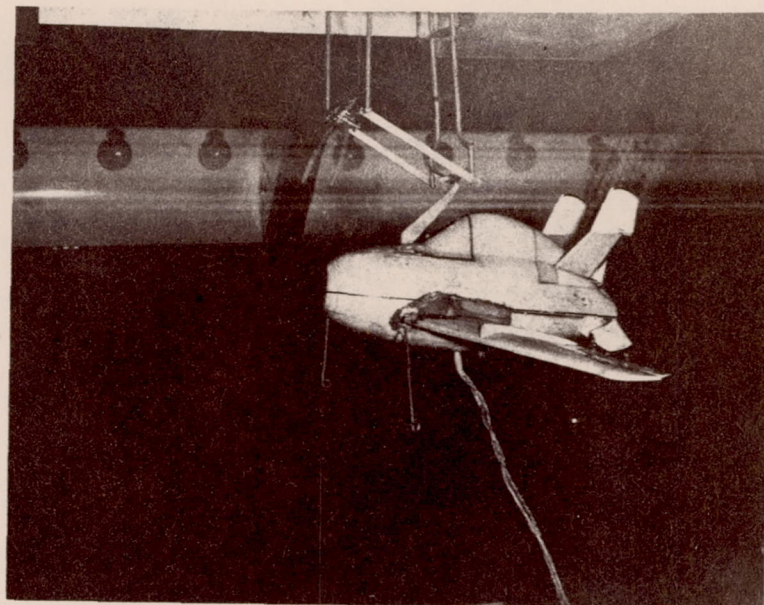
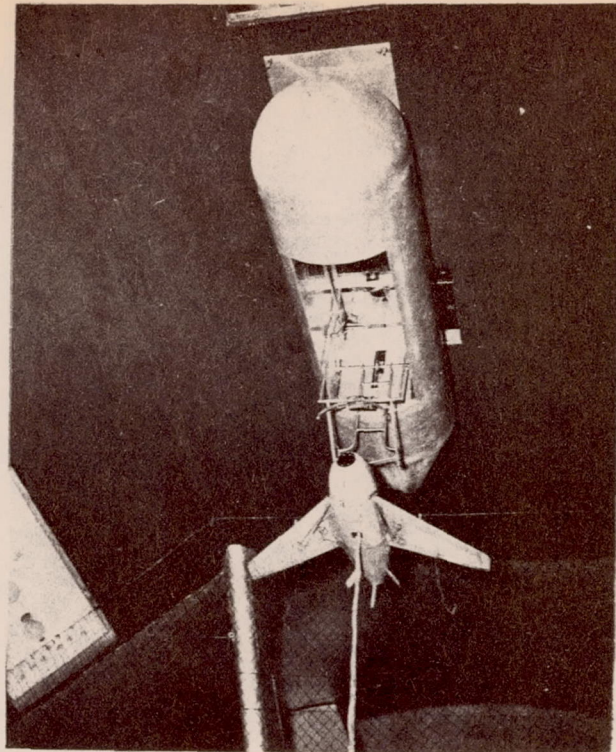
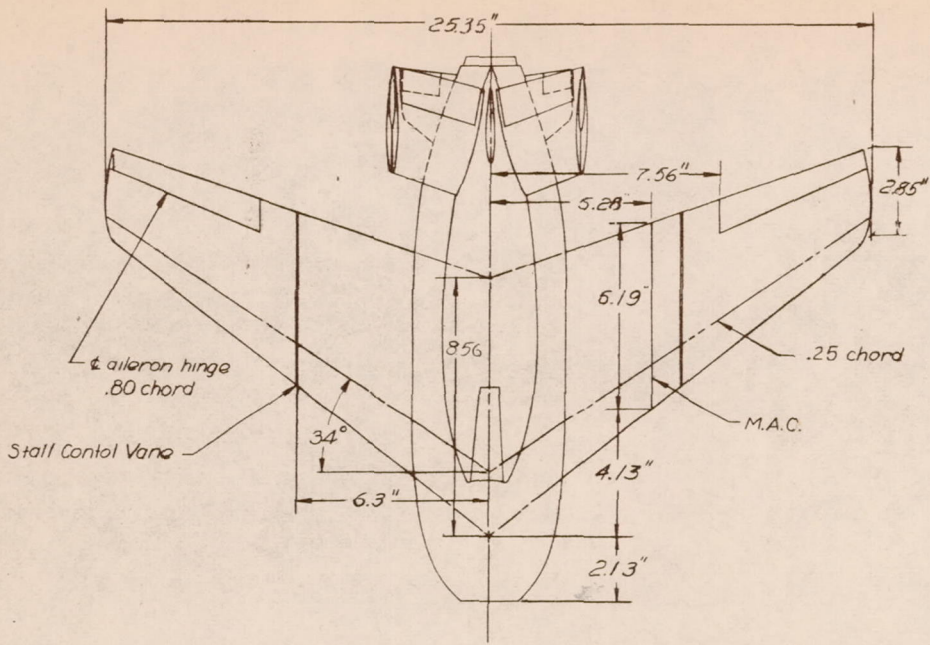

Figure 2.- One-tenth scale model of the McDonnell XP-85 airplane mounted on trapeze of  $\frac{1}{10}$ -scale mock-up of forward position of B-36 fuselage used for stability investigation in Langley free-flight tunnel.





Wing area	1.00 ft <sup>2</sup>
Span	2.10 ft.
Aspect ratio	4.40
Taper ratio	.33
C.G. location	.267 M.A.C.

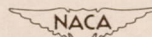
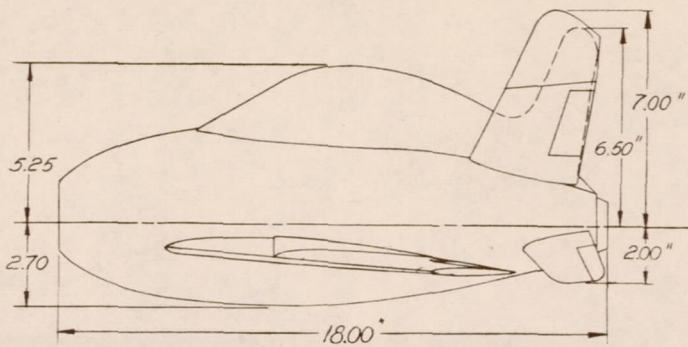
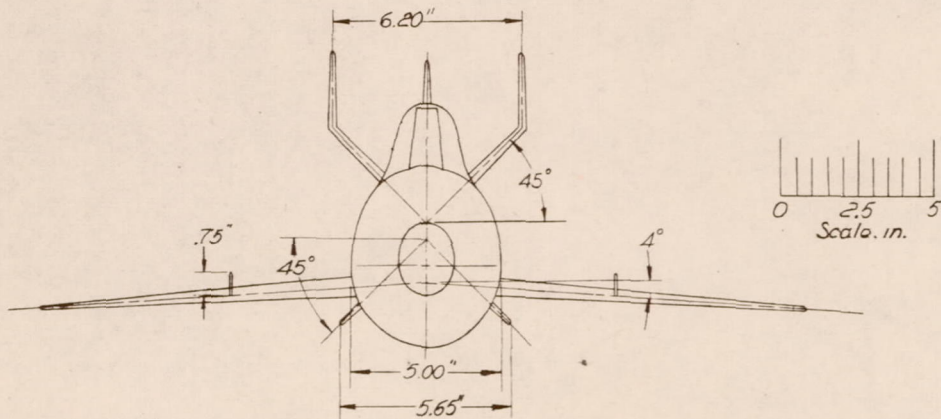

Figure 3- Three-view drawing of the  $\frac{1}{10}$ -scale model of the McDonnell XP-85 tested in the Langley free-flight tunnel. Five unit tail assembly.



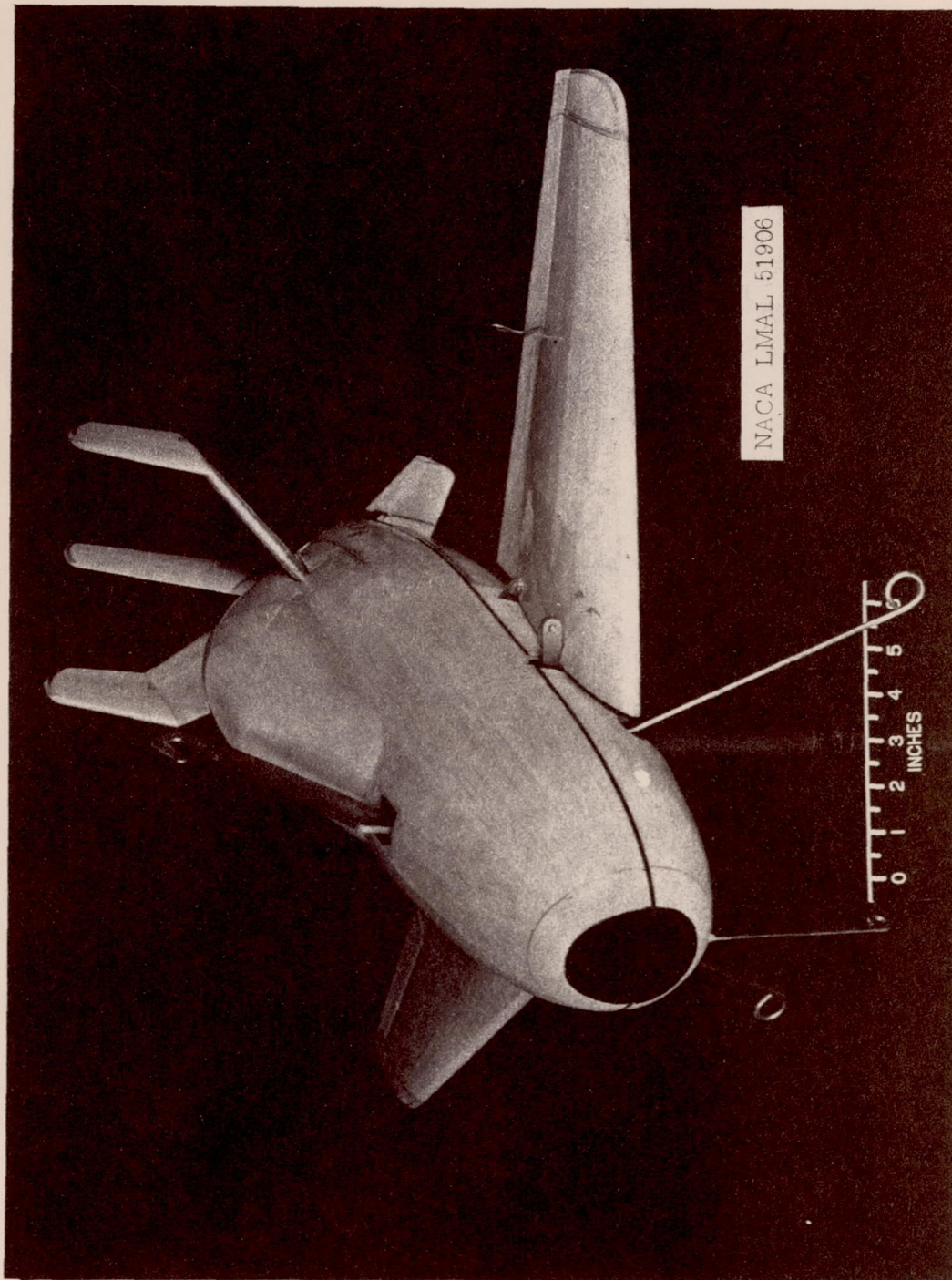

Figure 4.- Three-quarter front view of  $\frac{1}{10}$ -scale model of the McDonnell XP-85 airplane tested in the Langley free-flight tunnel.



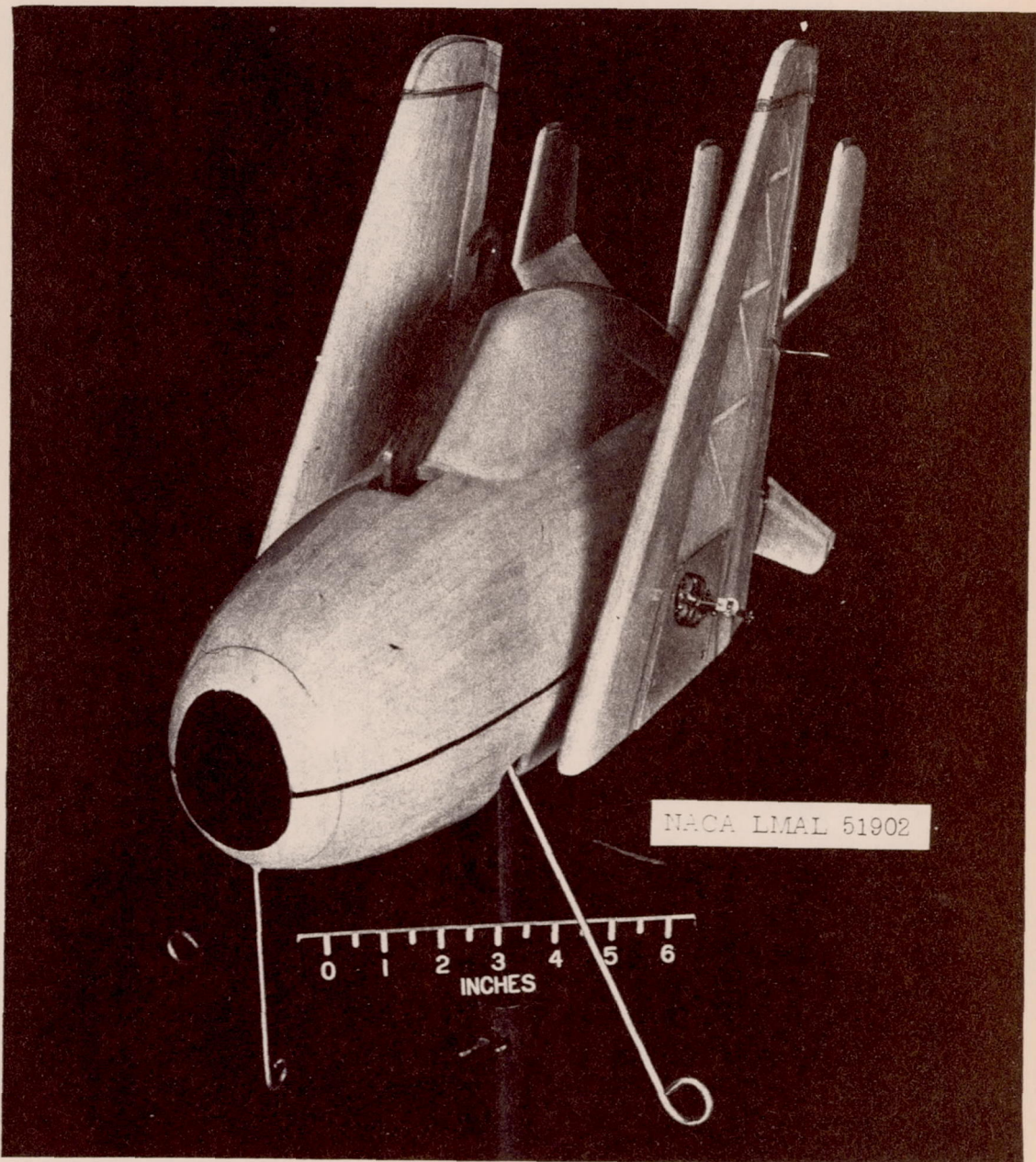

Figure 5.- Three-quarter front view of  $\frac{1}{10}$ -scale model of the McDonnell XP-85 airplane with wings in vertical position tested in the Langley free-flight tunnel.



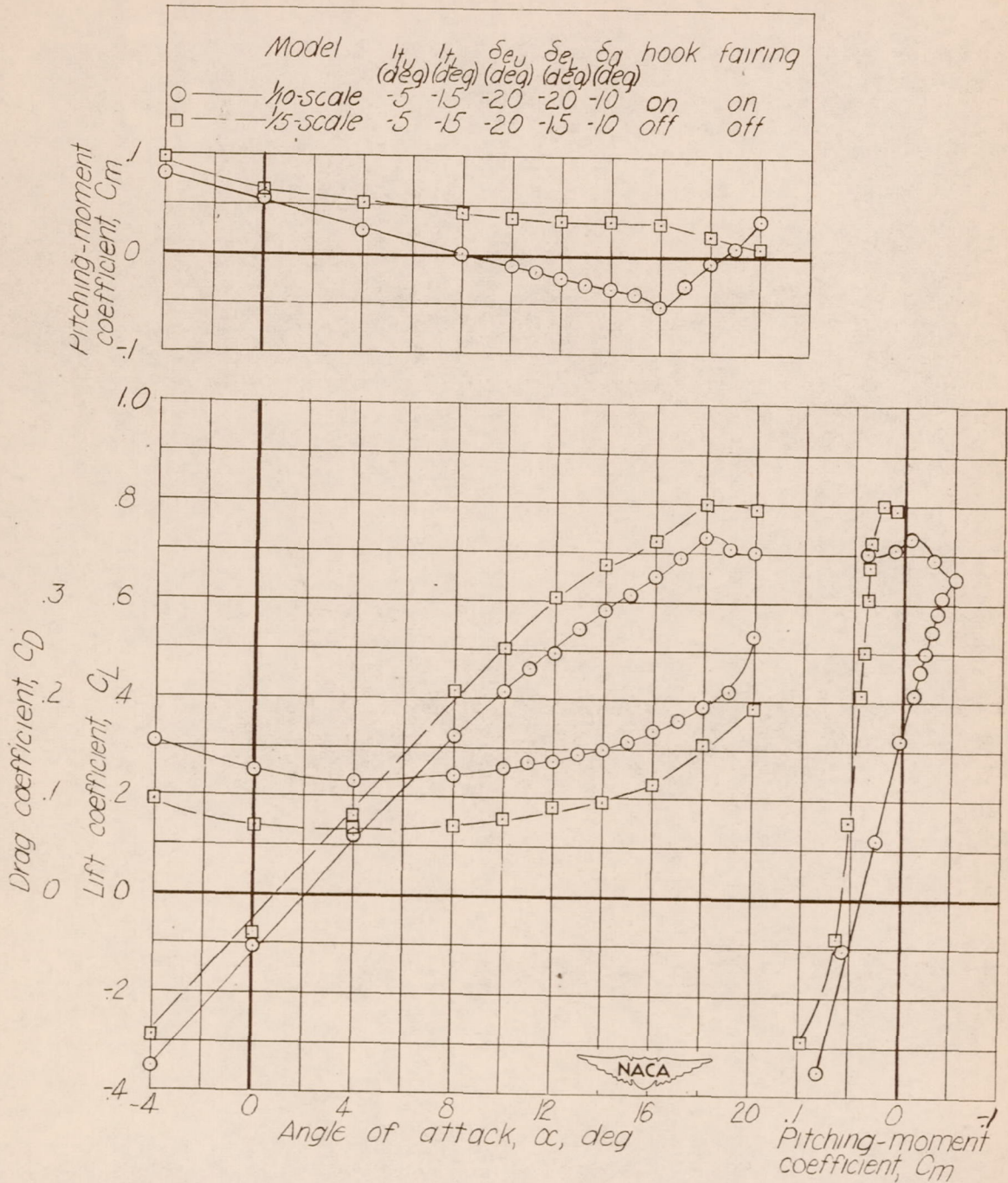

Figure 6.-Lift, drag, and pitching-moment characteristics of the 1/10-scale model of the Mc Donnell XP-85 airplane tested in the Langley free-flight tunnel compared with 1/5-scale model data from reference 1. Design configuration. Stall control vanes on. C.G. = 26.7 percent mean aerodynamic chord.  $\psi = 0^\circ$ ;  $\delta_r = 0^\circ$ .



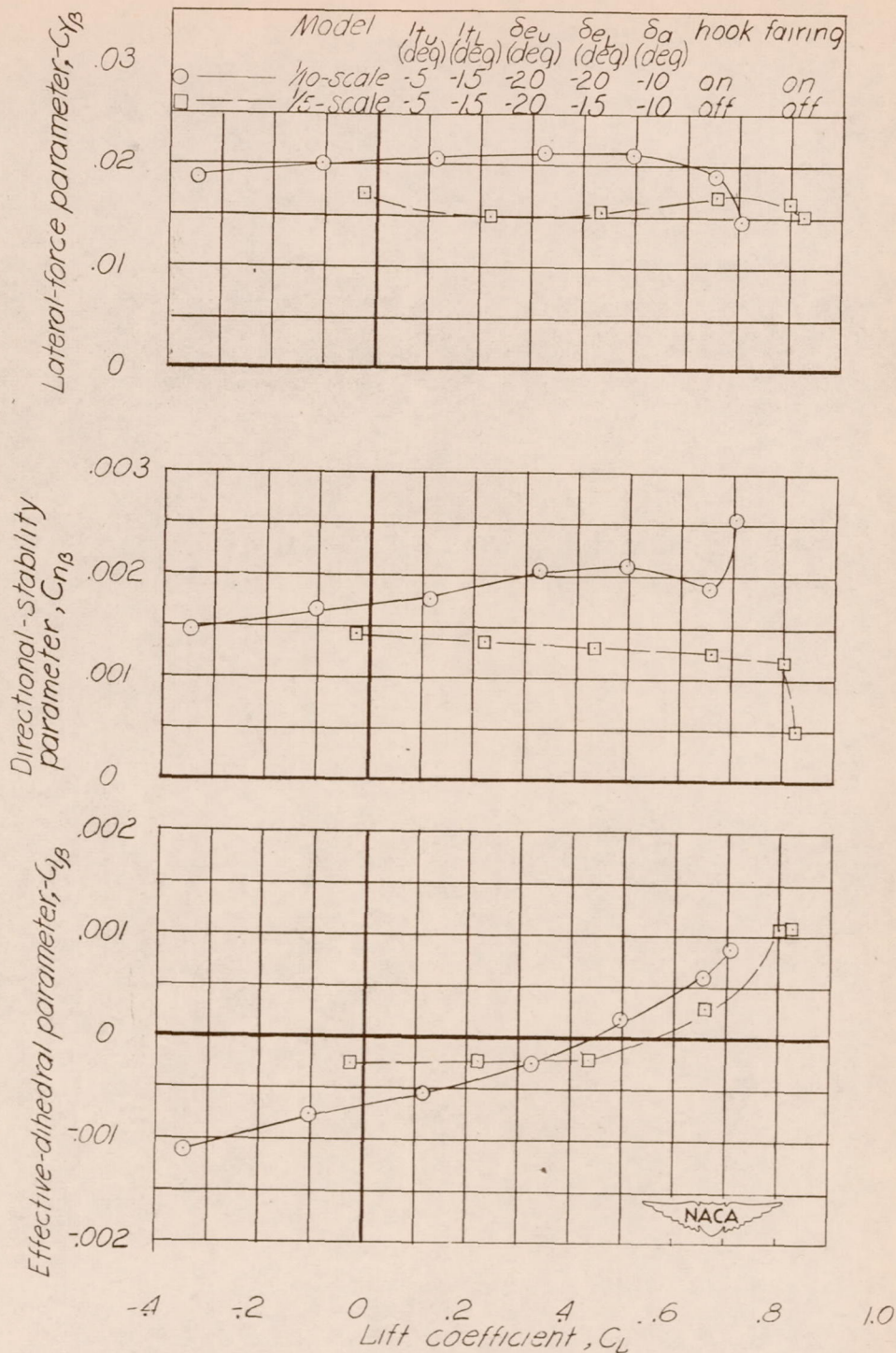

Figure 7.-Lateral stability characteristics of the  $1/10$ -scale model of the Mc Donnell XP-85 airplane tested in the Langley free-flight tunnel compared with  $1/5$ -scale model data from reference 1. Design configuration. Stall control vanes on. C.G. = 26.7 percent mean aerodynamic chord.  $\psi = 0^\circ$ ;  $\delta_r = 0$ .



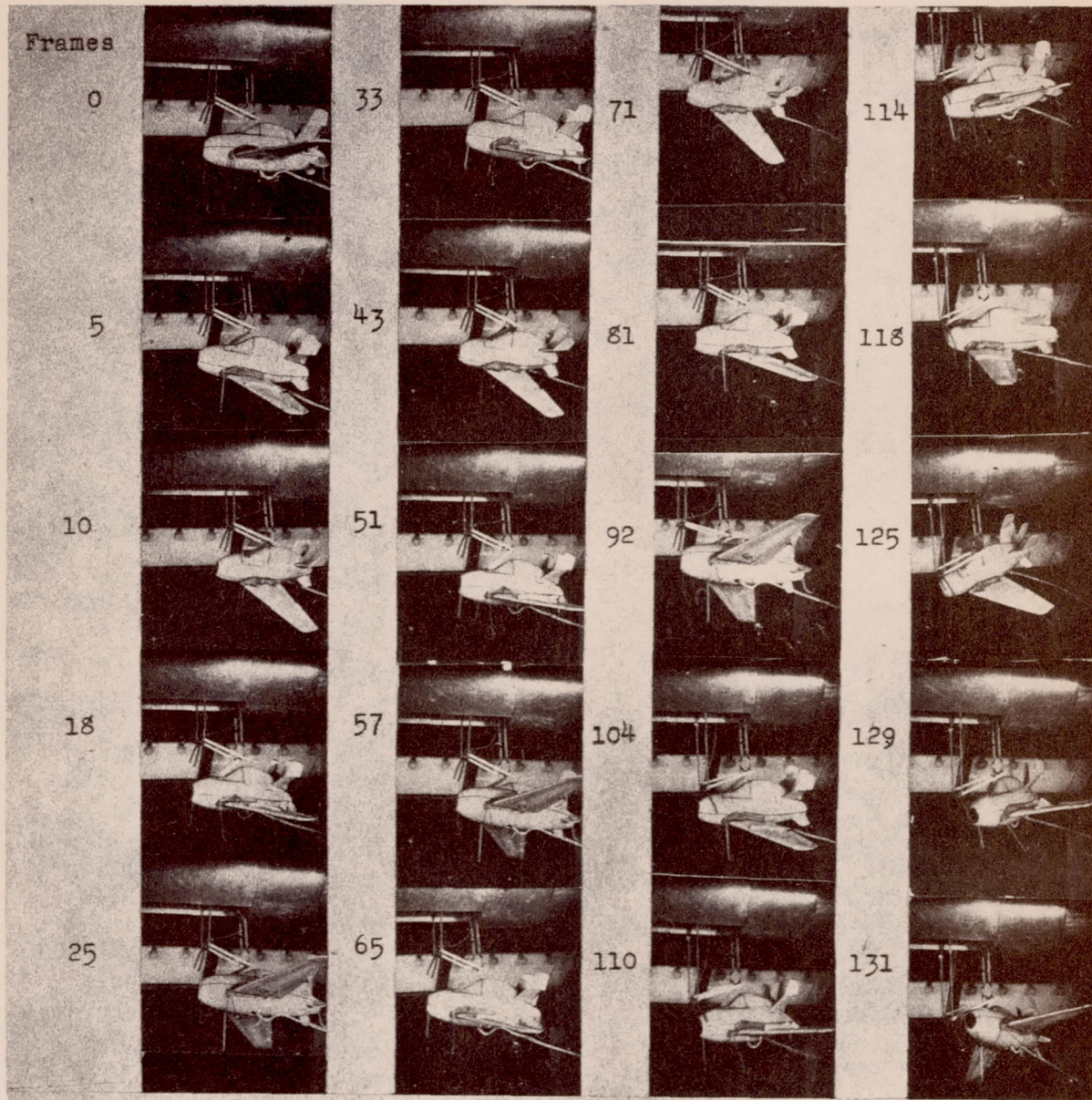

Figure 8.- Motion picture record of  $\frac{1}{10}$ -scale model of McDonnell XP-85 airplane showing nose clamp attempt with model in power-on condition. 32 frames per second.



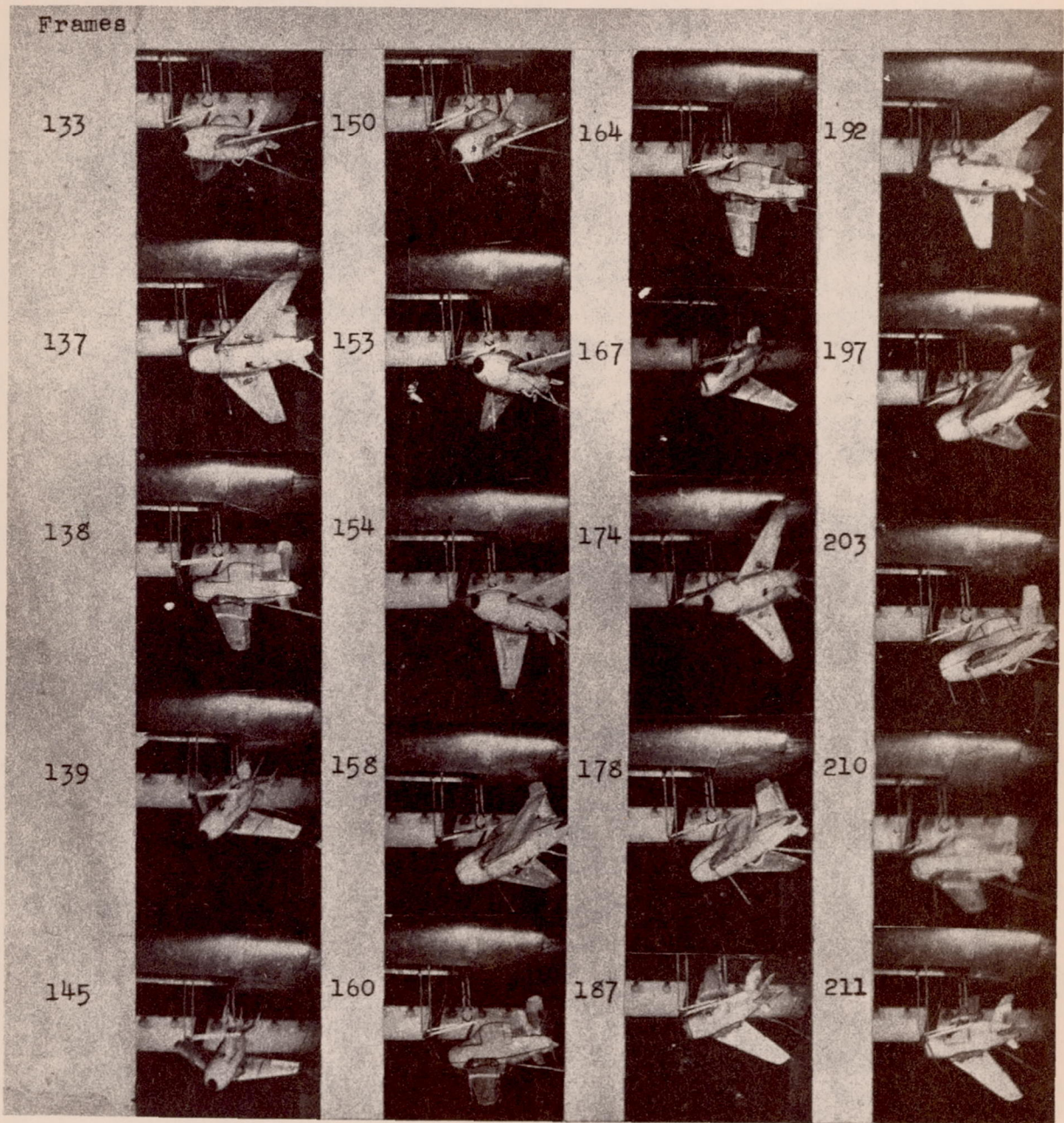

Figure 8.- Continued.



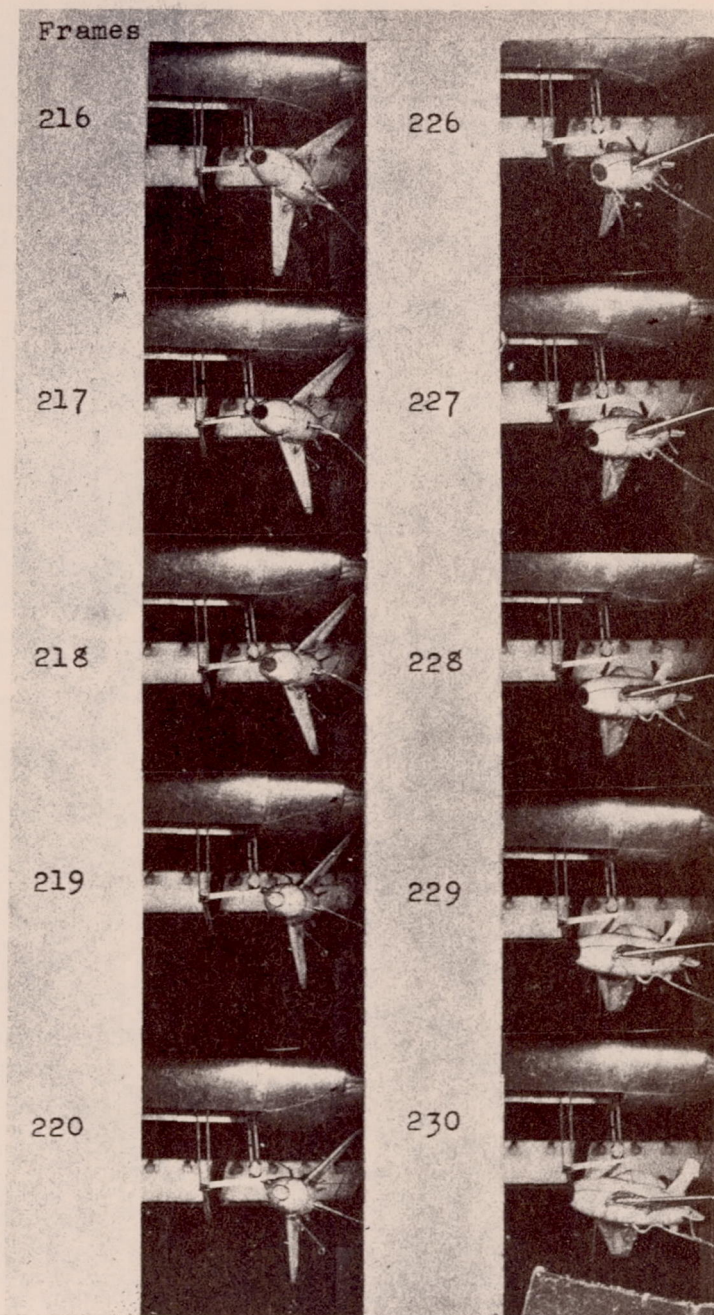

Figure 8.- Concluded.

NATIONAL ADVISORY COMMITTEE FOR AERONAUTICS  
LANGLEY MEMORIAL AERONAUTICAL LABORATORY - LANGLEY FIELD, VA



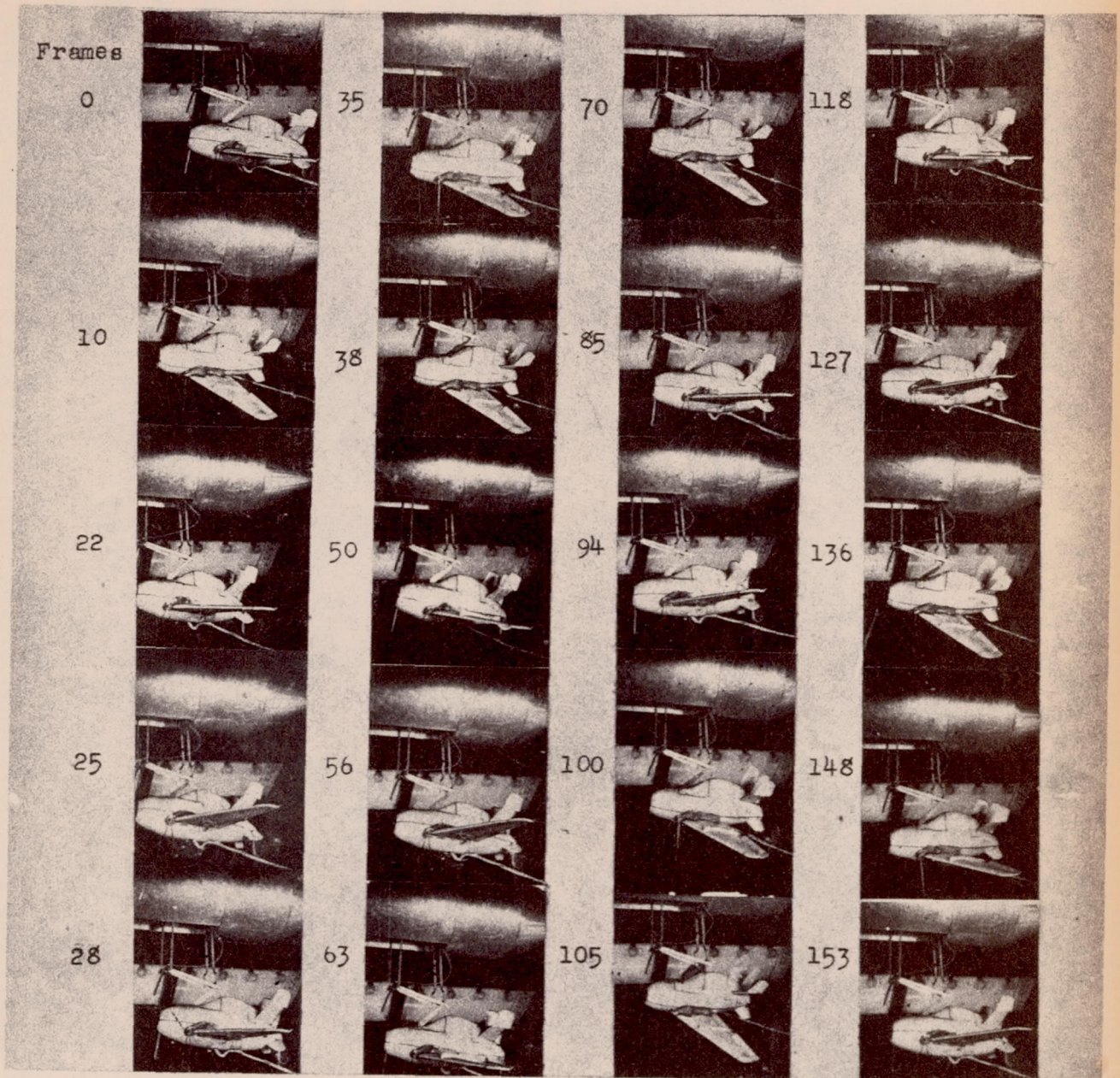

Figure 9.- Motion picture record of  $\frac{1}{10}$ -scale model of the McDonnell XP-85 airplane showing the effect of cutting power. 32 frames per second. (Tunnel angle cut progressively from  $-12^\circ$  to  $0^\circ$ , frames 0 to 426.)



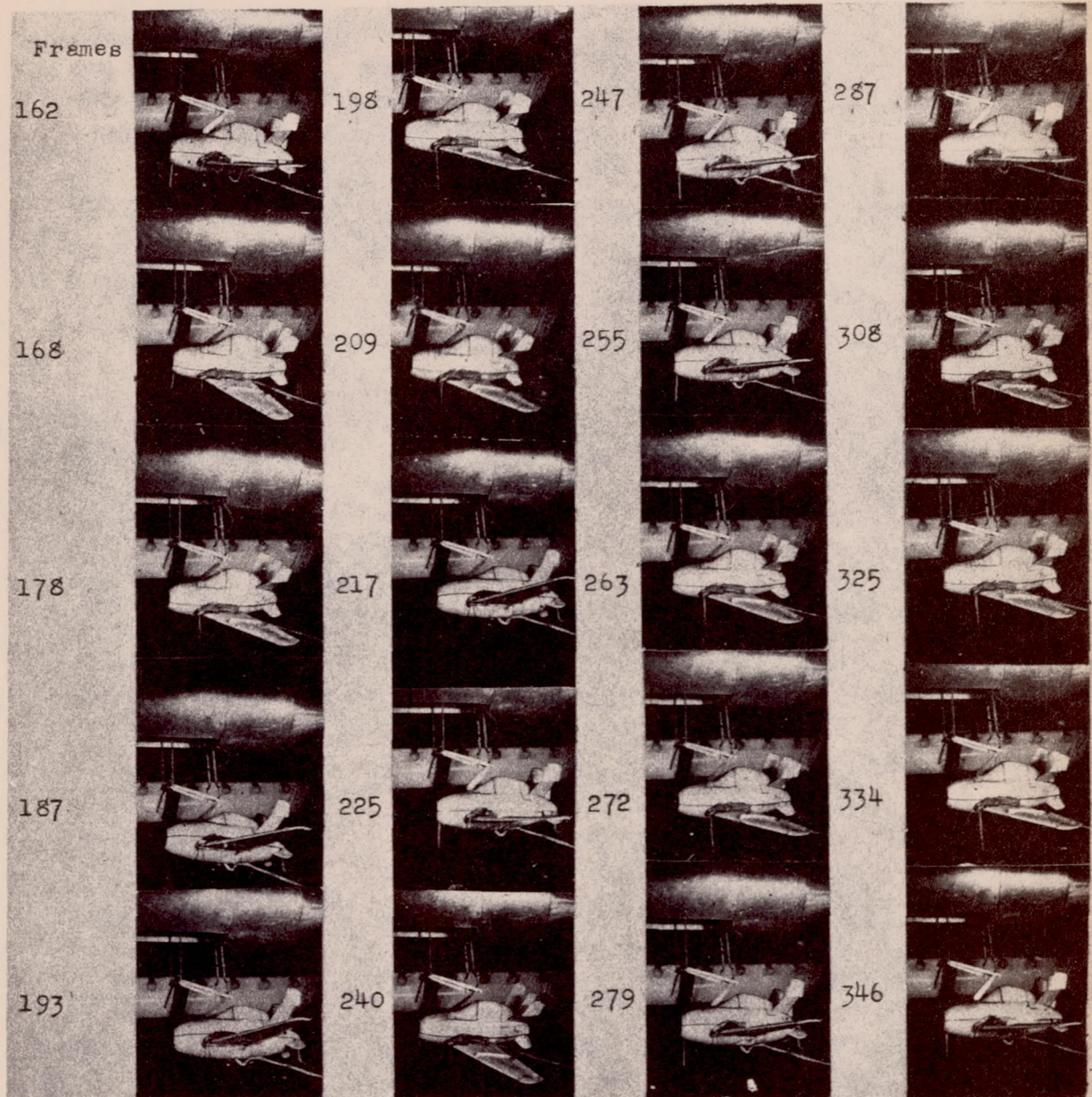

Figure 9.- Continued.



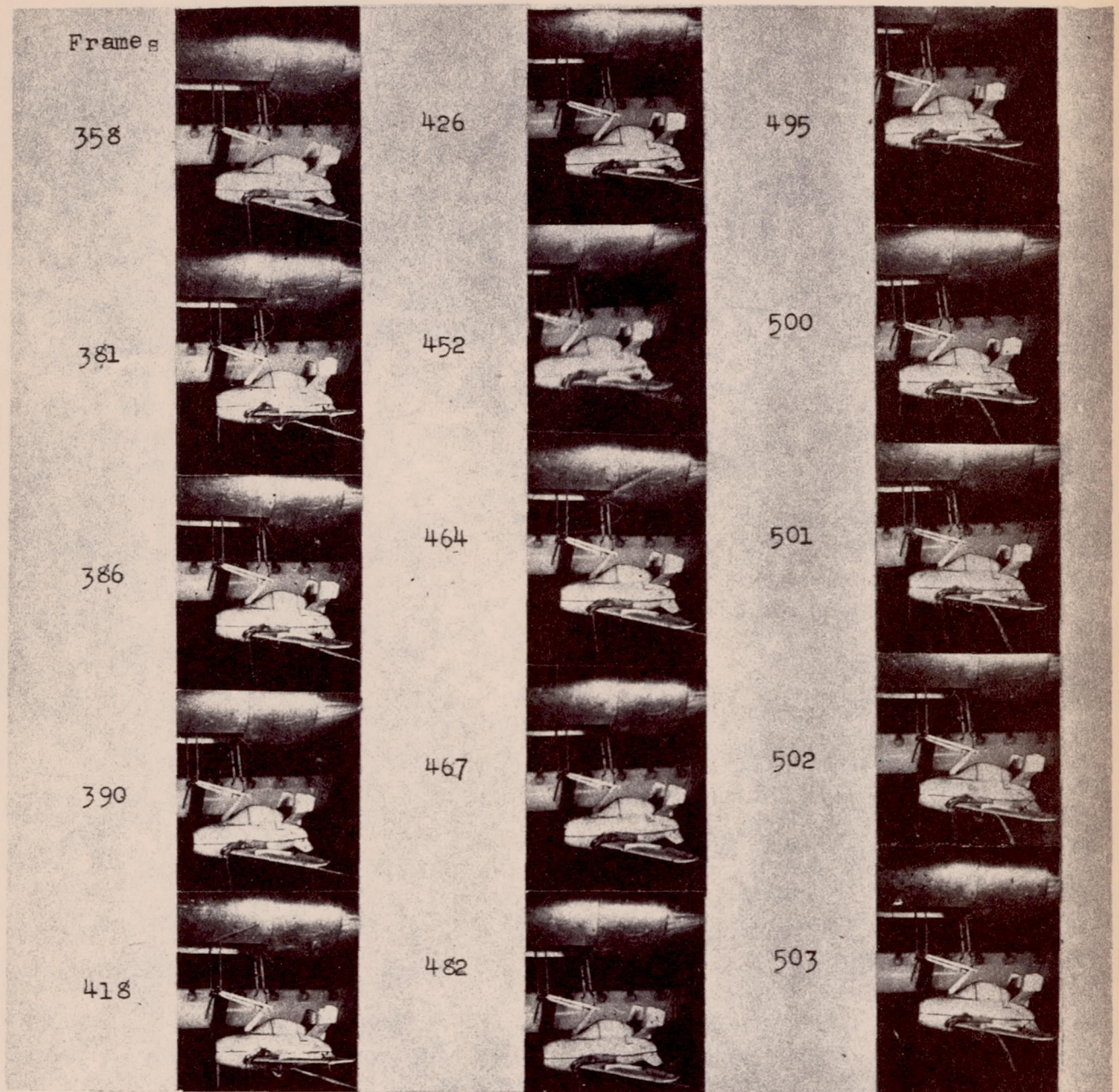
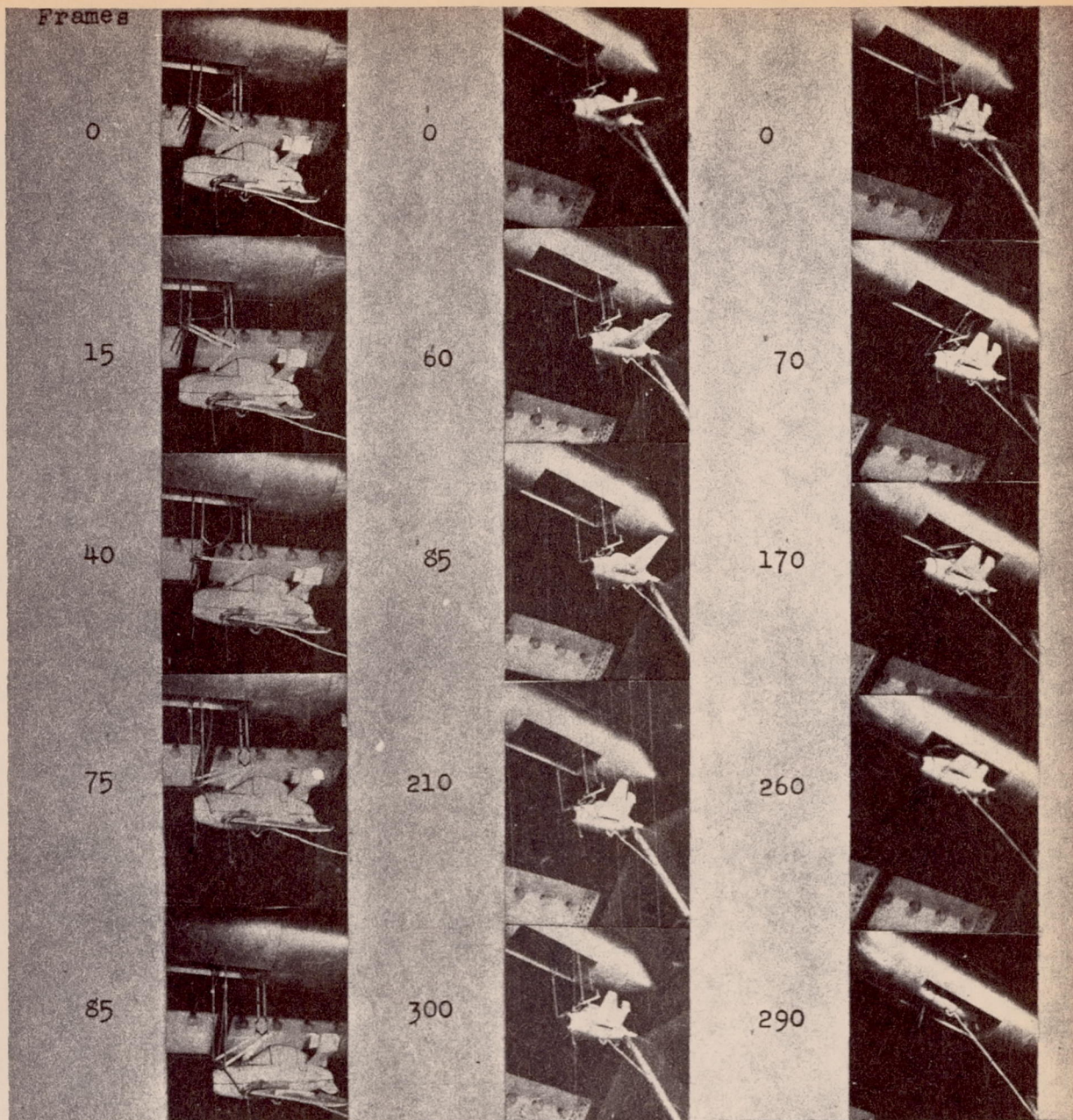

Figure 9.- Concluded.





Attachment of Collar

Folding of Wings

Retraction into bomb bay

Figure 10.- Motion picture record of  $\frac{1}{10}$ -scale model of the McDonnell XP-85 airplane showing attachment of collar with model in power-off condition, folding of wings, and retraction into bomb bay. 32 frames per second